

OCULUS | Centerfield® 2

Projection Perimeter



We focus on progress

OCULUS Centerfield® 2

Projection Perimeter for Visual Field Tests up to 70°

Since its launch in 2004 the OCULUS Centerfield® 2 has established a worldwide reputation for itself among ophthalmologists, optometrists and occupational physicians. Its closed design and the shaded view into the perimetric bowl allow for visual field examinations in normally lit rooms; therefore it is easy to use this practical table-top device almost anywhere. Operated by an external note computer the transportable Centerfield® 2 perimeter provides versatile configuration options that will cover the needs of any practice.

Clear Advantages

- **Always up to date:** Use of an external computer makes it possible to run the device with specific operating and analysis software which always keeps it on the cutting edge of today's rapidly changing information technology.
- **Employs all measurement principles:** The Centerfield® 2 perimeter performs automated static examinations as well as automated kinetic perimetry.
- **Networking capability:** The OCULUS Centerfield® 2 offers straightforward networking capabilities out of the box, DICOM compatibility and easy EHR integration.
- **Remarkable adaptability:** The OCULUS Centerfield® 2 is easy to customise with its versatile hardware configuration options and flexible examination programmes.



Standard Automated Perimetry

During static visual field examinations detailed information is collected on differential light sensitivity (DLS) in various test locations of the visual field. For this purpose standardised light stimuli (usually Goldmann size III) are presented to the patient in the perimeter from different directions. Responses are documented and assessed.

Sensitivity Threshold

Light stimuli of different intensities are perceived in different ways. Very bright spots are detected easily while very dark spots go undetected. The change between these two limiting cases is not abrupt, but rather occurs gradually over a certain range of luminance. The sensitivity threshold is given by the value of stimulus luminance at which there is a 50% probability of perception. Perimetric threshold values are expressed in decibels (dB). The reference value for this decibel scale is given by the maximum stimulus luminance of the perimeter.

Threshold Strategies

Strategies for threshold measurements make use of interpolation to determine sensitivity threshold values in all locations of a test pattern. The Centerfield® 2 perimeter provides various methods of taking threshold measurements: the classical 4-2 bracketing strategy ("Full Threshold"), OCULUS Fast Threshold, the original CLIP strategy and rapid SPARK.

Threshold Oriented Supra-Threshold Strategies

During examinations using these strategies the presented stimulus is always brighter than the one corresponding to the age – dependent normal threshold value in the respective location (hence the term supra-threshold strategy). Tests take less time, are easier to perform and overviews of the visual field are obtained without numerical dB values. The OCULUS Class Strategy and the 2- and 3-zone strategies are all suitable for fast screening exams using the Centerfield® 2 perimeter.

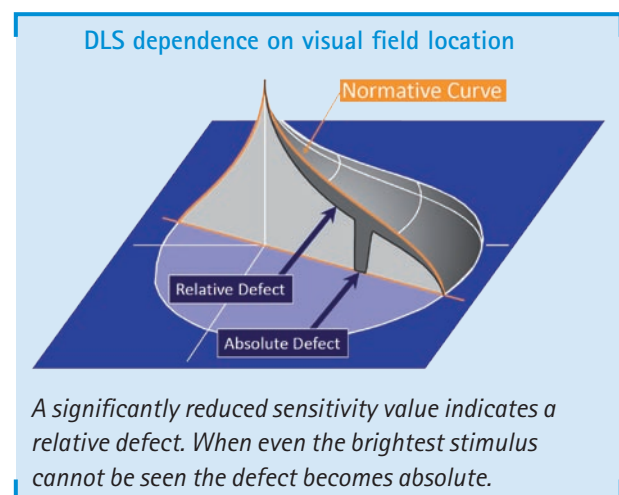
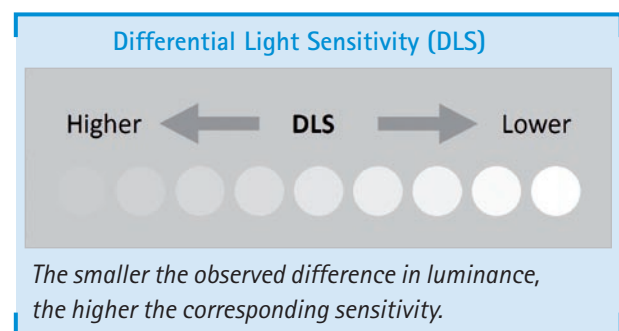

Comprehensive Perimetry

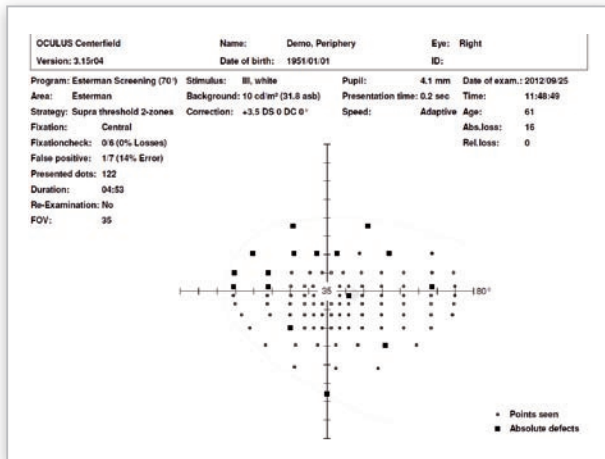

> Sample printout of a peripheral screening

Examine the Periphery: Beyond the Central Visual Field

Although static perimetry is usually performed within the central visual field (up to 30° eccentricity), there are also many compelling reasons for examining the periphery if the aim is to gain an overall impression of the entire visual field. Despite its compactness, the Centerfield® 2 perimeter has the capacity to test the visual field up to 70° in all directions. To overcome the limitations of the perimetric bowl an ingenious shift of the fixation target is made which extends the testing capabilities of the device. This procedure allows testing of extended patterns as in the Esterman test. Threshold strategies are not recommended for peripheral examinations, however.

Rediscover Kinetic Perimetry: When Nothing Else Works

The OCULUS Centerfield® 2 can revert to traditional kinetic testing when standard automated perimetry does not yield satisfactory results. In patients with very low visual acuity kinetic perimetry is sometimes the only method capable of providing additional information on the visual field. The examination can be performed with Goldmann size III stimuli and covers isopters within 35° of eccentricity.

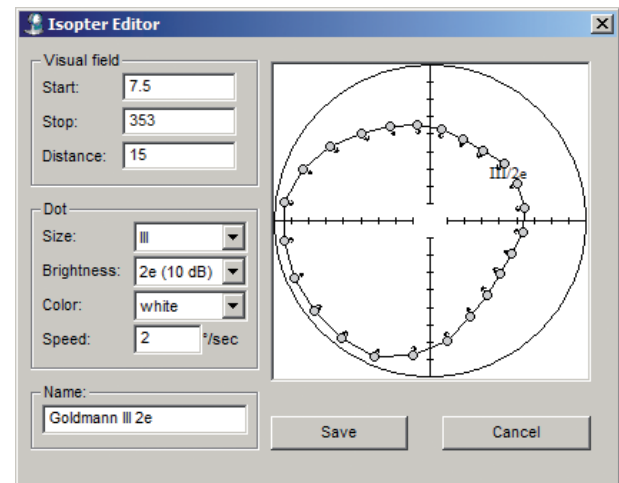

> Customising kinetic tests with the built-in isopter editor

Result Printout

All Information at a Glance

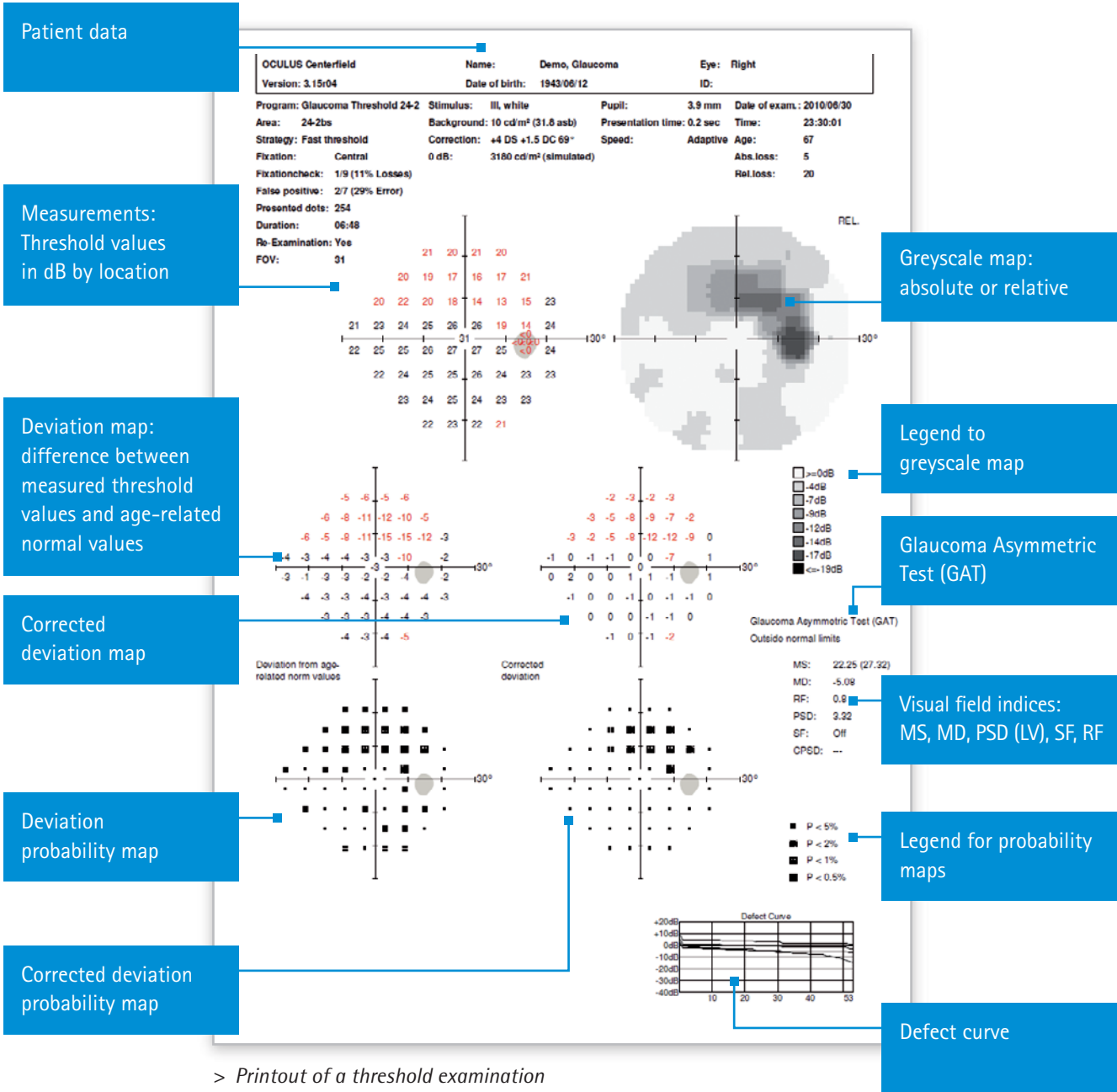

> Printout of a threshold examination

Fighting Glaucoma

Measurement – Assessment – Progression

The First Step: Screening for Glaucoma

Perimetry for glaucoma screening usually involves performing supra-threshold examinations of the central visual field. The Centerfield® 2 perimeter has a pre-defined “24-2” screening programme designed to obtain an overview of the visual field in a minimum of time. The device software makes it easy to create customised screening programmes using different test patterns which can be adapted to special requirements.

Increased Precision: The New SPARK Threshold Strategy

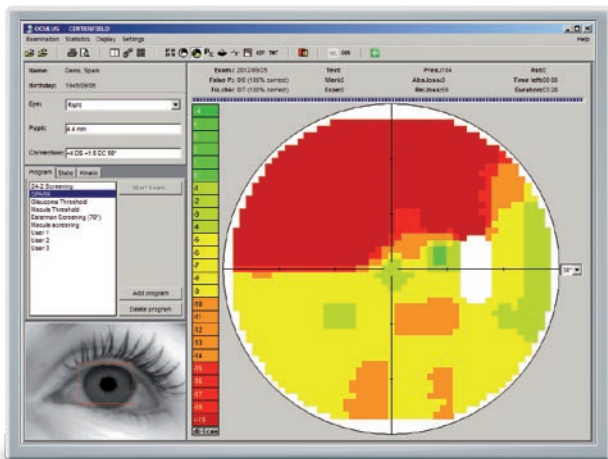

> *SPARK uses correlations between areas in a glaucomatous visual field to speed up threshold examinations*

The SPARK¹⁾ strategy is based on statistical relationships between threshold values corresponding to different locations in the glaucomatous visual field, derived from more than 90,000 perimetric examinations. High data yields ensure fast and very precise measurements of threshold values in the central visual field. The ingenious modular design of the four-phase procedure allows flexible use of the SPARK strategy in clinical practice:

- **SPARK Precision** is the full-fledged version of SPARK. Full-scale visual field examinations of glaucoma patients can be performed in just 3 minutes per eye. Averaging of the results over all four phases ensures a high degree of reliability and reproducibility for improved progression analysis.
- **SPARK Quick** is the perfect strategy for follow-up and screening examinations. The procedure only takes 90 seconds per eye.
- **SPARK Training** is ideal for patient training. This 40-second measurement can also be used for screening.

The SPARK strategy is available as an additional option in the OCULUS Centerfield® 2. It is fine-tuned for use in clinical examinations of glaucoma patients. Alternative software versions called SPARK-N are available for suspected cases of neurological pathology.

¹⁾ M. González de la Rosa, J Glaucoma 2013

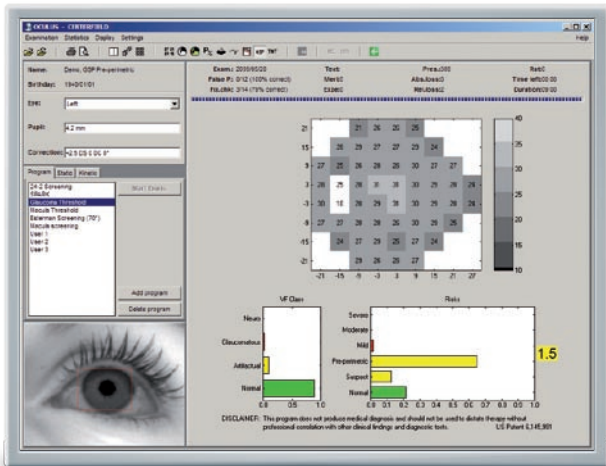

> GSP results display

Beyond Field Indices: Glaucoma Staging Program (GSP)

This novel evaluation module performs a thorough assessment of individual visual field findings using modern algorithms of pattern recognition. Besides providing a unique tool for early glaucoma diagnosis, GSP¹⁾ can be used to verify clinical evaluation of test results.

GSP classification is optimised to reproduce glaucoma expert opinions. The GSP database includes correlations with the entire clinical picture (including structural changes); this information enables GSP to evaluate risk and detect presence of glaucoma in various stages on the basis of visual field findings.

Intuitive green-yellow-red colour coding facilitates fast and reliable interpretation of findings. The striking novelty of GSP lies in its capability to identify both glaucoma suspect patients and patients with possible pre-perimetric glaucoma based on measured threshold values alone.

Efficient Progression Analysis: Threshold Noiseless Trend (TNT)

The TNT²⁾ software module provides objective evaluation of changes over time in visual field results. In combination with the fast SPARK strategy detection of progression in early glaucoma is enhanced considerably.

- TNT displays concise reports on the progression analysis with a summary of the most relevant parameters (MD slope, p-values, etc.).
- TNT can distinguish between cases of diffuse or focal progression in terms of the "Focality Index" (FI).
- TNT uses multiple statistical criteria in establishing progression.
- TNT presents age-related predictions on the visual field.

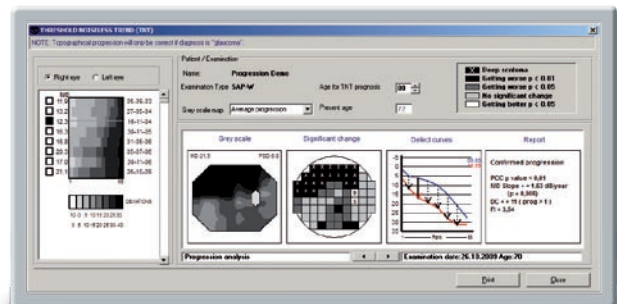

> TNT main display

¹⁾ D. Wroblewski et al, Graefes Arch Clin Exp Ophthalmol 2009

²⁾ M. González de la Rosa and M. González-Hernandez, Br. J. Ophthalmol. 2011; V.T Diaz-Aleman et al., Br. J. Ophthalmol. 2009

Technical Data

OCULUS Centerfield® 2

Static Perimetry	
Programmes	Pre-defined glaucoma, macula, screening and neurological tests; User-defined tests
Strategies	Threshold strategies: OCULUS Fast Threshold, Full Threshold (4-2), CLIP Optional: SPARK strategy Age-adapted supra-threshold screening (2-zone, 3-zone, quantify defects)
Test patterns	Orthogonal patterns (30-2, 24-2, 30x24, 10-2), physiological patterns (Area 1-8), Esterman, Profile, customised patterns
Stimulus size	Goldmann III
Stimulus colour	White/blue
Stimulus duration	200 ms/user-defined
Examination speed	Adaptive/slow/normal/fast/user-defined
Stimulus luminance range	0-318 cd/m ² (0-1000 asb)
Background luminance	10 cd/m ² (31.4 asb)
Background colours	White/yellow
Maximum eccentricity	36°/70° (with fixation shift)
Fixation control	CMOS camera, through central threshold, Heijl-Krakau (over blind spot)
Reports	Glaucoma Staging Program (GSP), Progression report for Threshold Noiseless Trend (TNT)
Kinetic perimetry	
Strategies	Automated tests along meridians with freely selectable density up to 35°
Stimulus speed	2°/s (Goldmann-Standard) or user-defined
Specifications	
Bowl radius	r = 30 cm
Patient positioning	Depth-adjustable headrest, optional motorised chinrest
Weight	12 kg (25.8 lbs); chinrest: 1 kg (2.4 lbs)
Operating voltage	100V - 240V
Operating system	Windows® XP or above
Interface	USB

CE in accordance with Medical Device Directive 93/42/EEC

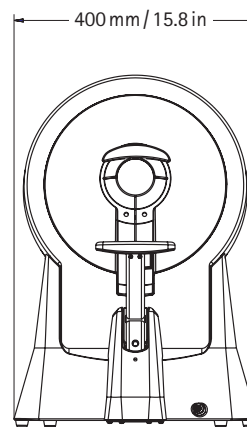
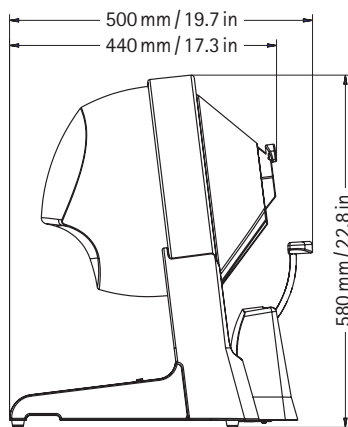

WWW.OCULUS.DE

OCULUS Optikgeräte GmbH
Postfach • 35549 Wetzlar • GERMANY
Tel. +49-641-2005-0 • Fax +49-641-2005-295
Email: export@oculus.de • www.oculus.de

- OCULUS USA, sales@oculususa.com
- OCULUS Asia, info@oculus.hk
- OCULUS Czechia, oculus@oculus.cz
- OCULUS Iberia, info@oculus.es
- OCULUS Poland, biuro@oculus.pl



OCULUS is certified by TÜV according to
DIN EN ISO 13485

